

Table of Contents

Usage Notice

| | |
|--------------------------|---|
| <i>Precautions</i> | 2 |
|--------------------------|---|

Introduction

| | |
|--------------------------------------|---|
| <i>Product Features</i> | 4 |
| <i>Package Overview</i> | 5 |
| <i>Product Overview</i> | 6 |
| <i>Main Unit</i> | 6 |
| <i>Control Panel</i> | 7 |
| <i>Connection Ports</i> | 8 |
| <i>Wireless Remote Control</i> | 9 |

Installation

| | |
|---|----|
| <i>Connecting the Projector</i> | 10 |
| <i>Powering On/Off the Projector</i> | 11 |
| <i>Powering On the Projector</i> | 11 |
| <i>Powering Off the Projector</i> | 12 |
| <i>Adjusting the Projected Image</i> | 13 |
| <i>Adjusting the Image Height</i> | 13 |
| <i>Adjusting the Projector's Zoom/Focus</i> | 14 |

User Controls











| | |
|---|----|
| <i>Control Panel & Remote Control</i> | 15 |
| <i>Onscreen Display Menus</i> | 18 |
| <i>How to Operate</i> | 18 |
| <i>Menu Tree</i> | 19 |
| <i>Picture</i> | 20 |
| <i>Image</i> | 22 |
| <i>System</i> | 24 |
| <i>Display</i> | 25 |

Appendices

| | |
|---|----|
| <i>Troubleshooting</i> | 27 |
| <i>Replacing the Lamp</i> | 30 |
| <i>Ceiling Mount Installation</i> | 31 |
| <i>Throw Angle</i> | 32 |

Precautions

Follow all warnings, precautions, and maintenance procedures as recommended in this user's guide.

-  **Warning-** Do not look into the lens. The bright light may cause eye injury.
-  **Warning-** To reduce the risk of fire or electric shock, do not expose this product to rain or moisture.
-  **Warning-** To prevent the risk of electric shock, do not open or disassemble the product.
-  **Warning-** Please allow the unit to cool down before changing the lamp; carefully follow the lamp replacement instructions listed under "Replacing the Lamp."
-  **Warning-** This product self-detects the life cycle of the lamp and will display a warning message when the lamp is about to expire. Be sure to replace the lamp when it displays warning messages.
-  **Warning-** After installing a new lamp, reset the lamp life using the onscreen menu.
-  **Warning-** Before turning off the product, allow the cooling fan to run for several minutes.
-  **Warning-** Turn on the projector first and then select the signal sources.
-  **Warning-** Do not use lens cap when projector is in operation.
-  **Warning-** When the lamp reaches the end of its life, it will burn out and may make a loud "popping" sound. If this occurs, the projector will not turn back on until the lamp module has been replaced. To replace the lamp, follow the procedures listed under "Replacing the Lamp."

Do:

- ❖ Turn off the product before cleaning.
- ❖ Use a soft cloth moistened with mild detergent to clean the display housing.
- ❖ Disconnect the power plug from AC outlet if the product is not being used for a long period of time.

Do not:

- ❖ Block the slots and openings on the unit provided for ventilation.
- ❖ Place in direct sunlight.
- ❖ Use abrasive cleaners, waxes, or solvents to clean the unit.
- ❖ Use under the following conditions:
 - Extreme heat, cold, or humidity.
 - In areas susceptible to excessive dust and dirt.
 - Near any appliance generating a strong magnetic field.

Product Features

This product is a WVGA single chip DLP™ projector featuring:

- ◆ True WVGA resolution 854 x 480 addressable pixels
- ◆ Single 480p DarkChip2™ chip DLP™ technology
- ◆ HDTV compatible (480i/p, 576i/p, 720p, 1080i)
- ◆ NTSC/NTSC4.43/PAL/PAL-M/PAL-N/SECAM, and HDTV compatible
- ◆ HDCP compliant
- ◆ Hi-tech DVI-I connection for digital and analog video connectivity
- ◆ Built in de-interlacing with 3:2 and 2:2 pull down
- ◆ Wireless remote control
- ◆ User-friendly multilingual on-screen display menu
- ◆ Advanced **digital** keystone correction and high quality full screen image re-scaling
- ◆ User-friendly control panel

Package Overview

This projector comes with all the items shown below. Check to make sure your unit is complete.



Projector with lens cap



Power Cord 1.8m



RS232 Cable 1.8m



S-Video Cable 2.0m



Composite Video Cable
1.8m



DVI to HDMI Adaptor
(Option)



DVI to D-Sub Adaptor
(Option)



SCART RGB/S-Video
Adaptor
(For European Use Only)



Wireless Remote
Controller



❖ Due to the difference in applications for each country, some regions may have different accessories.



Carrying Case



Battery x 2

Documents :

- User's Manual
- Warranty Card

Introduction

Product Overview

Main Unit



1. Control Panel
2. Zoom Ring
3. Focus Ring
4. Zoom Lens
5. IR Receivers
6. Connection Ports
7. Power Socket

Control Panel

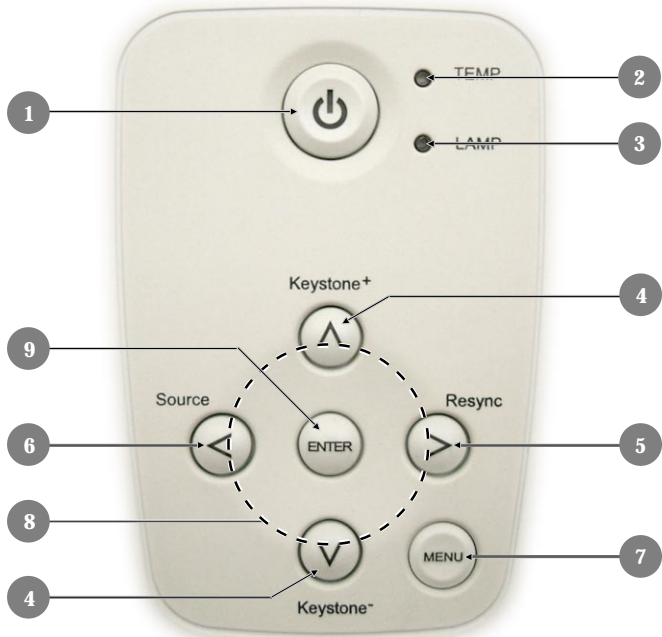

1. Power/Standby
2. Temp Indicator LED
3. Lamp Indicator LED
4. Keystone Correction
5. Re-sync
6. Source
7. Menu/Exit
8. Four Directional Select Keys
9. Enter

Introduction

Connection Ports

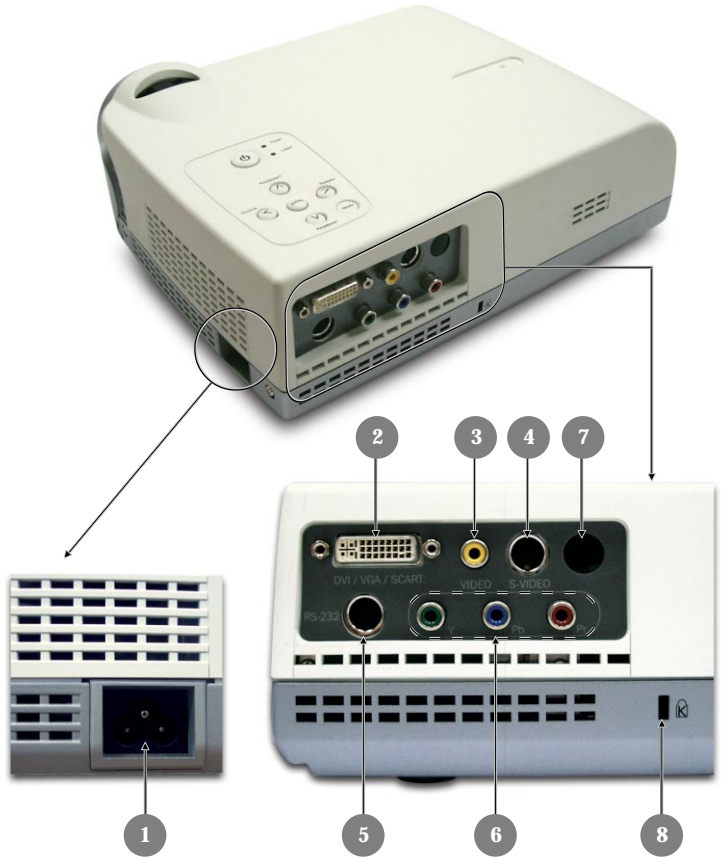

- 1 Power Socket
- 2 DVI-I Input Connector (PC Digital and Analog signal/ SCART RGB/HDTV/HDCP/Component Video Input)
- 3 Composite Video Input Connector
- 4 S-Video Input Connector
- 5 RS232 Input Connector
- 6 Component Video Input RCA Connectors
- 7 IR Receiver
- 8 Kensington™ Lock Port

Wireless Remote Control

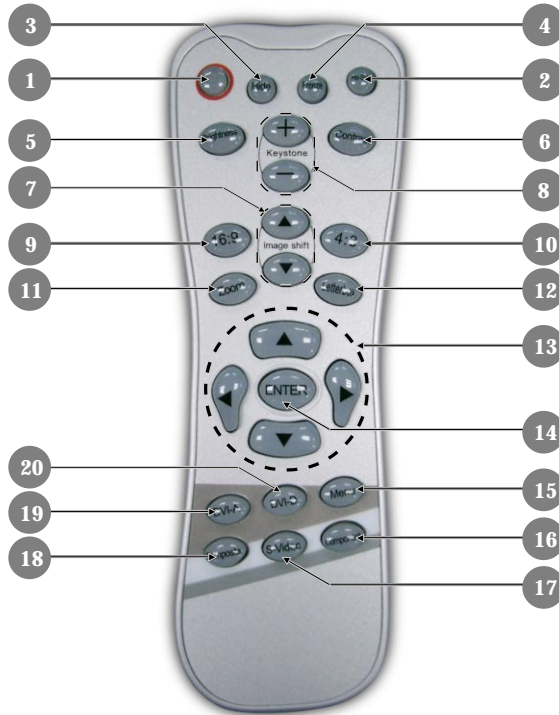

- | | |
|------------------------|----------------------------------|
| 1. Power On/Off | 13. Four Directional Select Keys |
| 2. Re-sync | 14. Enter |
| 3. Display Hide | 15. Menu/Exit |
| 4. Freeze | 16. Component Source (YPbPr) |
| 5. Brightness | 17. S-Video Source |
| 6. Contrast | 18. Composite Source |
| 7. Image Shift | 19. DVI-A Source |
| 8. Keystone Adjustment | 20. DVI-D Source |
| 9. 16:9 | |
| 10. 4:3 | |
| 11. Zoom | |
| 12. Letterbox | |

Connecting the Projector

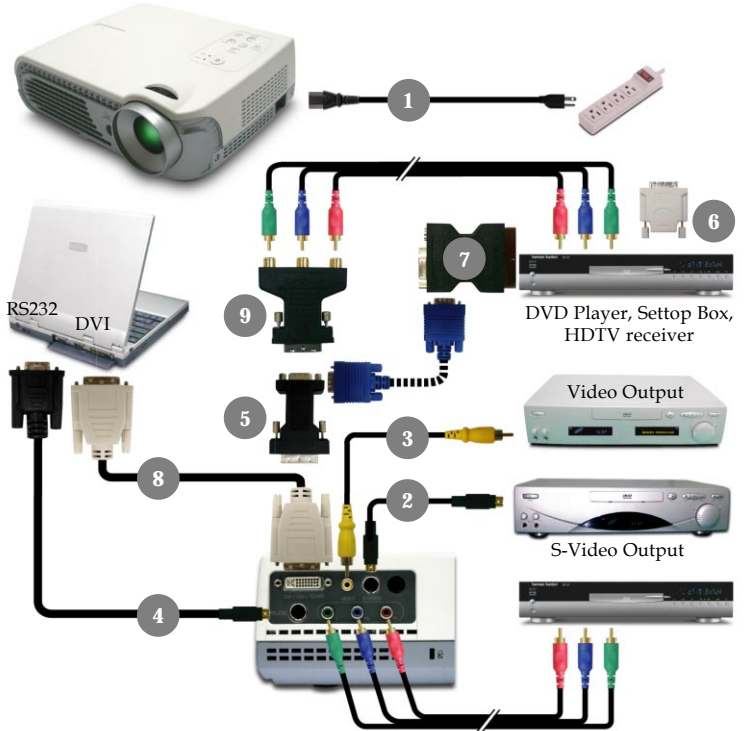

1. Power Cord
2. S-Video Cable
3. Composite Video Cable
4. RS232 Cable
5. DVI to D-Sub Adaptor
6. DVI to HDMI Adaptor
7. SCART RGB/S-Video Adaptor (For European Use Only)
8. DVI to DVI Cable (Optional)
9. DVI to RCA Adaptor for YPbPr (Optional)

Powering On/Off the Projector

Powering On the Projector

1. Remove the lens cap.
 2. Ensure that both the power cord and signal cable are securely connected.
 3. Turn on the power and lamp by pressing the “Power” button on the control panel. The start-up screen will be displayed in approximately one minute.
 4. Turn on your source (computer, notebook, or video player, etc...); the projector will automatically detect your source.
- ❖ *If the screen displays “No Signal,” please make sure the signal cables are securely connected.*
 - ❖ *If you connect multiple sources at the same time, use the “Source” button on the control panel to select the desired source.*



- ❖ Turn on the projector first followed by the signal sources.



Powering Off the Projector

1. Press the “Power” button to turn off the projector lamp, you will see the following message “Power off the lamp? ” displayed on the screen.
2. Press the “Power” button again to confirm. Otherwise the message will disappear after **5** seconds.
3. The cooling fans continue to operate for about 120 seconds for cooling cycle and the Power LED will **turn red**. When the light **stops flashing**, the projector has entered standby mode.

If you wish to turn the projector back on, you must wait until the projector has completed the cooling cycle and has entered standby mode. Once in standby mode, simply press “Power” button to restart the projector.

4. Disconnect the power cord from the electrical outlet and the projector.
 5. Do not turn on the projector immediately following a power off procedure.
- ❖ *When the “LAMP” indicator lights orange continuously, the lamp may failed. Please contact your local reseller or service center.*
 - ❖ *When the “TEMP” indicator flashes orange for about ten seconds, you will see a message “Fan Fail” or “Over Temperature” on the display. The projector will automatically shut down. After cooling, under normal conditions, the projector can be switched on again for your presentation. If the problem persists, contact your local reseller or service center.*

Adjusting the Projected Image

Adjusting the Image Height

The projector is equipped with an elevator foot to adjust the image height.

To raise or lower the image :

1. Turn the projector over and locate the elevator foot. Press the elevator button **1** to extend the foot so it may be adjusted.
2. While holding down the elevator button, adjust the foot to the desired height, **2** then release the button to lock the elevator foot into position.
3. Use **3** to fine-tune tilt-adjustment
4. Lower the projector so it rests on its foot; adjust as needed.

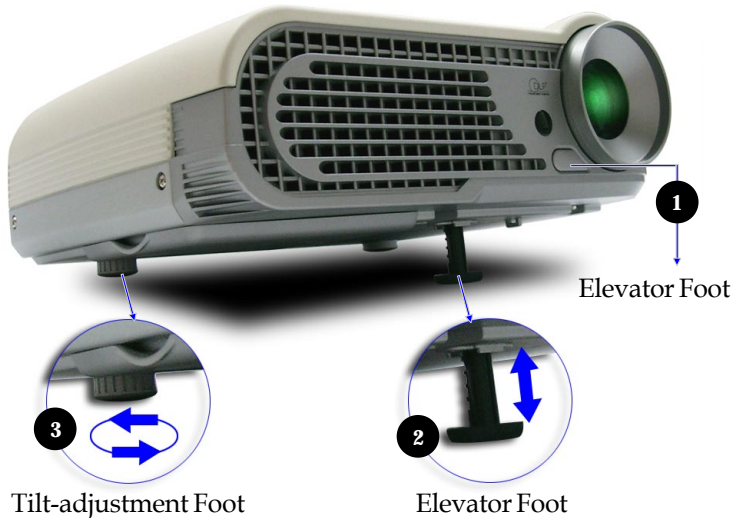

Installation

Adjusting the Projector's Zoom/Focus

You may adjust the zoom to zoom the lens in or out. Turn the zoom ring to zoom in or zoom out. To focus on the image, turn the focus ring until you see a clear image. The projector will focus at distances from 4.6 to 39.4 feet (1.4 to 12.0m).

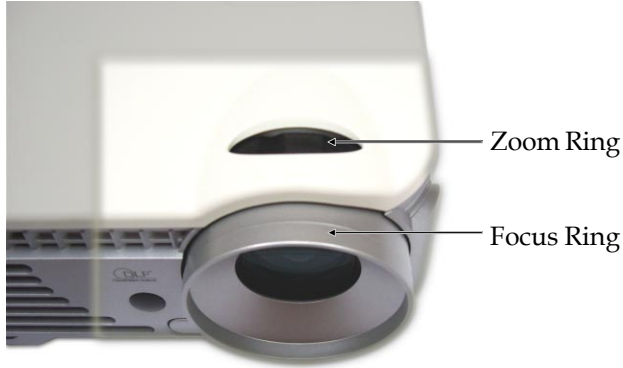

Control Panel & Remote Control

There are two ways to control the functions: with remote control and control panel.

Remote Control



Control Panel



Using the Remote Control

Power

- ▶ “Power” turns on the projector’s lamp. Refer to the “Powering On/Off the Projector” section on page 11~ 12 for more details.

Hide

- ▶ “Hide” immediately turns the screen black. Press “Hide” again to restore the displayed image.

Freeze

- ▶ “Freeze” pauses the screen image, press “Freeze” again to un-pause.

Re-Sync

- ▶ Automatically synchronizes the projector with the input source.

User Controls

Brightness

- ▶ Adjust the brightness of the image.

Zoom

- ▶ Zoom in or out.

Contrast

- ▶ Control the degree of difference between the lightest and darkest parts of the picture.

Keystone +/-

- ▶ Correct image distortion caused by tilting the projector.

4 : 3

- ▶ Scale the image at a 4:3 aspect ratio.

16 : 9

- ▶ Scale the image at a 16:9 aspect ratio.

Letterbox

- ▶ Enable the viewing of the letterboxed non-anamorphically enhanced movie at full screen width. Part of the original image will be lost if the image aspect ratio is less than 1.78:1.

Image shift ▲ ▼

- ▶ Shifts the projected image position vertically.

Four Directional Select Keys

- ▶ Press "Menu", then use ▲ ▼ ◀ ▶ to select menu items or to make adjustments to your selection.

Enter

- ▶ Confirm your selection.

Menu/Exit

- ▶ Display or exits the onscreen display menu.

DVI-A

- ▶ Choose DVI-Analog source.

DVI-D

- ▶ Choose DVI-Digital source.

Composite

- ▶ Choose video source.

S-Video

- ▶ Choose S-Video source.

Component

- ▶ Choose Component-i and Component-p sources.

Using the Control Panel

Power/Standby

- ▶ Refer to the “Power On/Off the Projector” section on pages 11-12.

Source

- ▶ Press “Source” to choose RGB, S-Video, SCART RGB, Composite, Component and HDTV sources.

Menu/Exit

- ▶ Display or exits the onscreen display menus.

Keystone + /-

- ▶ Adjusts image distortion caused by tilting the projector (± 16 degrees).

Four Directional Select Keys

- ▶ Press “Menu,” then use     to select items or make adjustments to your selection.

Enter

- ▶ Confirm your selection of items.

Re-Sync

- ▶ Automatically synchronizes the projector with the input source.

On-screen Display Menus

How to Operate

- ▶ The projector has multilingual on-screen display menus that allow you to make image adjustments and change a variety of settings. The projector automatically detects the source.
- ▶ Press “Menu” on the Remote Control or Control Panel.
- ▶ When the menu is displayed, use ▲ ▼ ◀ ▶ to navigate the main menu. To Select a specific icon, press “Enter” to access related.
 - ◆ To exit the main menu, press “Menu”.
- ▶ When a sub menu is displayed, use ▲ ▼ to select the desired item and adjust the settings with ◀ ▶ .
 - ◆ To exit the sub menu, press “Menu”.
- ▶ After using ◀ ▶ to make selections within the sub menu, press “Enter” to confirm your changes and return to the sub menu.
 - ◆ Press “Menu” to return to the main menu. If you do not press “Enter” to confirm your changes before exiting, the items will not to be modified.

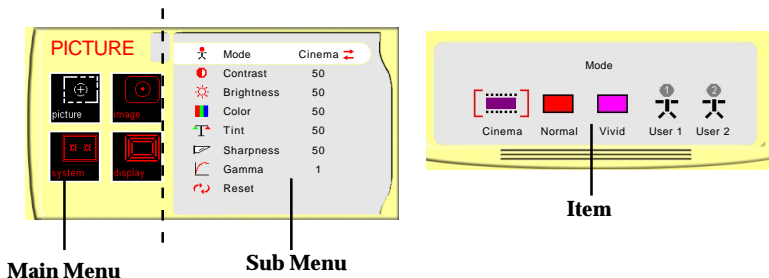

Menu Tree

| | | |
|-------------------|---------------------|--|
| PICTURE..... | Mode | Cinema/Normal/Vivid/User 1/User 2 |
| | Contrast | |
| | Brightness | |
| | Color (Video only) | |
| | Tint (Video only) | |
| | Sharpness | |
| | Gamma | |
| | Reset | Current/All |
| IMAGE..... | White Peaking | 1/2/3 |
| | Color Temp | Film/Video/Graphics/PC |
| | Image Mode | R Contrast/G Contrast/B Contrast/R Brightness/G Brightness/B Brightness |
| | Advanced Adjustment | |
| | Signal | Horizontal/Vertical/Frequency/Phase |
| | Reset | Current/All |
| SYSTEM..... | Language | English/Français/Deutsch/Español/Italiano/Português/Русский/繁體中文/日本語/한국어 |
| | Bulb | Lamp Hour/Lamp Reminding/Lamp Reset |
| | Source Lock | On/Off |
| | Auto Shutdown | On/Off |
| | Blanking | Blue/Black |
| | Brite Mode | On/Off |
| | High Altitude | On/Off |
| | DISPLAY..... | Projection |
| Format | | |
| Keystone | | 4:3/16:9 |
| Zoom Mode | | |
| Full Screen Mode | | Normal/1.66/1.85/2.35 |
| 4:3 Mode | | 1/2/3 |
| 1080i Mode | | 1/2 |
| Lens Shift Preset | | 1/2/Off |
| Edge Mask | | On/Off |

User Controls

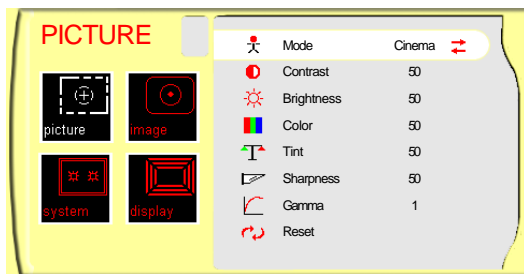

PICTURE

Mode

There are three factory presets optimized for various types of pictures: cinema, normal and vivid. You can customize contrast, brightness, intensity, color, tint, sharpness, and gamma for each preset mode.

Contrast

Contrast controls the degree of difference between the lightest and darkest parts of the picture. Adjusting the contrast changes the amount of black and white in the image.

- ▶ Press ◀ to decrease the contrast.
- ▶ Press ▶ to increase the contrast.

Brightness

Adjust the brightness of the image.

- ▶ Press ◀ to darken image.
- ▶ Press ▶ to lighten image.

Color

Adjust a video image from black and white to fully saturated color.

- ▶ Press ◀ to decrease the amount of color in the image.
- ▶ Press ▶ to increase the amount of color in the image.

Tint

Adjust the color balance of red and green.

- ▶ Press ◀ to increase the amount of green in the image.
- ▶ Press ▶ to increase the amount of red in the image.

Sharpness

Adjust the sharpness of the image.

- ▶ Press ◀ to decrease the sharpness.
- ▶ Press ▶ to increase the sharpness.



❖ The "Tint" sub menu is not supported under the Component Video or Analog RGB input sources.

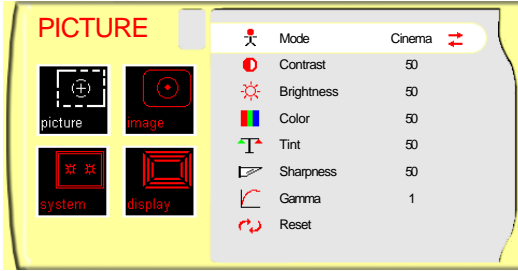

PICTURE

Gamma

Gamma affects how dark scenery is displayed. With a greater gamma value, dark scenery will look brighter. Use ◀ ▶ to adjust gamma values.

Reset

Return the adjustments and settings to the factory default values.

- ▶ Current: Returns the current menu's settings to factory default values.
- ▶ All: Returns the settings for all menus to factory default values.

User Controls

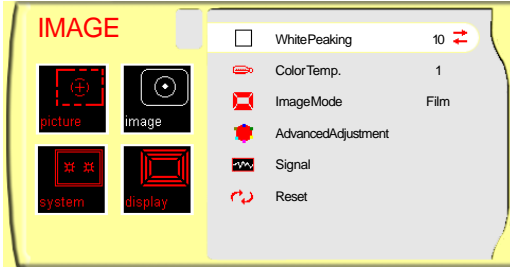

IMAGE

White Peaking

The white peaking control adjusts the white segment of the DMD chip. “0” stands for minimal peaking, and “10” stands for maximum peaking. If you prefer a stronger image, adjust toward the maximum setting. For a smoother, more natural image, adjust towards the minimum setting.

Color Temp.

The color temp control adjusts the color temperature of the image. The range is from “1” to “3”. At a higher temperature, the screen looks colder; at a lower temperature, the screen looks warmer.

Image Mode

There are four factory presets optimized for various types of images.

- ▶ Film : For home theater
- ▶ Video : For video mode
- ▶ Graphic : For graphics
- ▶ PC : For computers

Advanced Adjustment

Use ◀ or ▶ to select R (Red), G (Green), or B (Blue) for advanced adjustment of brightness and contrast of the individual colors.

Signal

- ▶ Horizontal: Adjusts the horizontal position.
- ▶ Vertical: Adjusts the vertical position.
- ▶ Frequency: Changes the display data frequency to match the frequency of your computer’s graphics card. If you experience a vertical flickering bar, use this function to correct the issue.



❖ The “Signal” sub menu is supported under the Analog RGB and Analog YPbPr input sources.

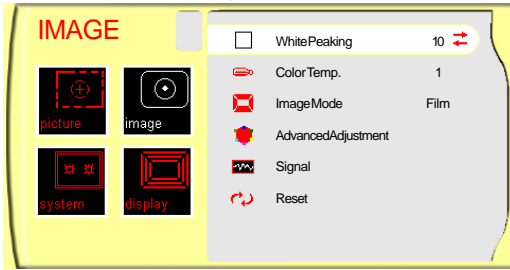

IMAGE

- ▶ **Phase** : Synchronizes the signal timing of the display with the graphics card. If you experience an unstable or flickering image, use this function to correct it.

Reset

Return the adjustments and settings to factory default values.

- ▶ **Current**: Returns the current menu's settings to factory default values.
- ▶ **All**: Returns all menu settings to factory default values.

User Controls

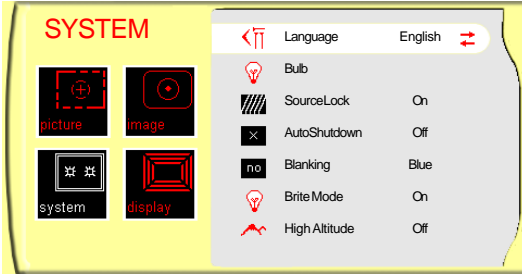

SYSTEM

Language

Displays a multilingual menu. Use ◀ and ▶ to select your preferred language.

Bulb

- ▶ Lamp Hours: Displays the cumulative lamp operating time.
- ▶ Lamp Reminding: Choose this function to show or hide the warning message when the lamp replacement message is displayed. The message will show up when the lamp reaches 1500 hours.
- ▶ Lamp Hour Reset: Reset the lamp setting only when the new lamp is replaced.

Source Lock

When turned off, the projector will search for other signals if the current input signal is lost. When turned on, it will continue to search for the “lost signal” after “Source” is pressed.

Auto Shutdown

Decide the time interval to shutdown the system if there is no signal input. Select “On” to turn the projector off automatically.

Blanking

Use this feature to display a black or blue screen when no signal is available.

Brite Mode

Choose “On” to increase light output. Choose “Off” to return normal mode.

High Altitude

Choose “On” to turn on High Altitude mode operates the fans at full speed continuously to allow for proper high altitude cooling of the projector.

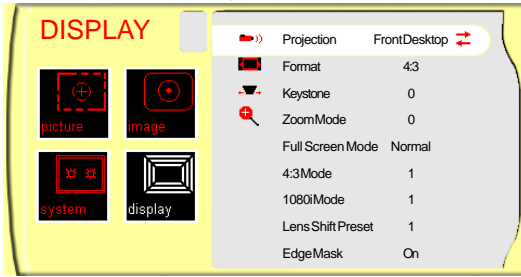

DISPLAY

Projection

▶  **Front-Desktop**

The factory default setting.

▶  **Rear-Desktop**

When you select this function, the projector reverses the image so you may project from behind a translucent screen.

▶  **Front-Ceiling**

When you select this function, the projector turns the image upside down to accommodate ceiling-mounted projection.

▶  **Rear-Ceiling**

When you select this function, the projector reverses and turns the image upside down at same time. You can display an image from behind a translucent screen with ceiling mounted projection.

Format

Use this function to choose your desired aspect ratio.

- ▶ 4:3 : The input source will be scaled to fit the projection screen.
- ▶ 16:9 : The input source will be scaled to fit the width of the screen.

Keystone

Correct image distortion caused by tilting the projector vertically.

Zoom Mode

Provide different magnification ratios to zoom an image. Images will be centered after zooming.

Full Screen Mode

Intend to fill up full 16:9 screen for video with aspect ratio such 1.85:1, 1.66:1, 2.35:1 and Normal (Original image pixel).

User Controls

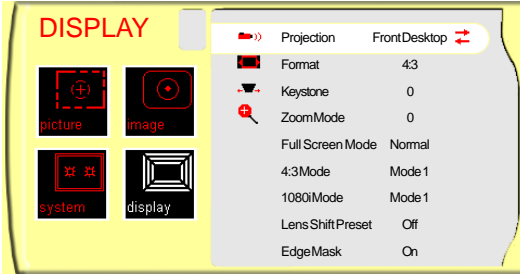

DISPLAY

4:3 Mode

- ▶ 1 : Scale to 640 x 480 pixel.
- ▶ 2 : Scale to 854 x 480 pixel stretch horizontally.
- ▶ 3 : Scale to 854 x 638 pixel crop to 854 x 480.

1080i Mode

- ▶ 1 : Scale to 854 x 480 pixel.
- ▶ 2 : Scales 1080i signal to 960 x 540 and displays the middle 854 x 480 pixels.

Lens Shift Preset

Shifts the projected image position vertically. 0 is middle of the screen. You can be stored to preset values by selecting either preset memory 1 or 2 or OFF before adjusting image.

Edge Mask

Choose "On" to mask off a few pixels on each edge of the image to be displayed. Use Edge Mask "On" if image source happens to have encoding error near any edge of the displayable image.

Troubleshooting

If you experience trouble with the projector, please refer to the following information (listed below). If the problem persists, contact your local reseller or service center immediately.

Problem: No image appears on screen.

- ▶ Ensure that all cables and power connections are correctly and securely connected as described in the “Installation” section.
- ▶ Ensure that the pins of connectors are not crooked or broken.
- ▶ Check to see if the projection lamp has been securely installed. Please refer to the “Replacing the Lamp” section for more information.
- ▶ Make sure that you have removed the lens cap and that the projector is powered on.
- ▶ Ensure that the “Hide” feature is not turned on.

Problem: Partial, scrolling or incorrectly displayed images

- ▶ Press “Re-Sync” on the Remote Control or Control Panel.
- ▶ If you are using a PC:

For Windows 3.x:

1. In the Windows Program Manager, double click the “Windows Setup” icon in the Main group.
2. Verify that your display resolution setting is less than or equal to 1280 x 1024.

For Windows 95, 98, 2000, XP:

1. From the “My Computer” icon, open the “Control Panel” folder, and double click the “Display” icon.
2. Select the “Settings” tab
3. Click on the “Advanced Properties” button.

If the projector is still not displaying the entire image, you may need to change the monitor display that you are using. Refer to the following steps.

4. Verify the resolution setting is less than or equal to 1280 x 1024 resolution.
 5. Select the “Change” button under the “Monitor” tab .
 6. Click on “Show all devices.” Next, select “Standard monitor types” under the SP box; choose the resolution mode you need under the “Models” box.
 7. Verify that the resolution setting of the monitor display is less than or equal to 1280 x 1024.
- ▶ If you are using a Notebook PC:
 1. First, follow the steps above to adjust resolution of the computer.
 2. Switch the Notebook PC display to the “external display only” or “CRT only” mode.
 - ▶ If you experience difficulty changing resolutions or your monitor freezes, restart all equipment including the projector.

Problem: The screen of the Notebook or PowerBook computer is not displaying a presentation.

- ▶ If you are using a Notebook PC:

Some Notebook PCs may deactivate their own screens when a second display device is in use. Each has a different way to be reactivated. Refer to your computer’s documentation for detailed information.

Problem: Image is unstable or flickering

- ▶ Use “Phase” to correct it. See page 23 for more information.
- ▶ Change the monitor color setting or the frequency on your computer.

Problem: Image has vertical flickering bar

- ▶ Use “Frequency” to make an adjustment. See page 22 for more information.
- ▶ Check and reconfigure the display mode of your graphics card to ensure compatibility.

Problem: Image is out of focus

- ▶ Adjust the focus ring on the projector's lens.
- ▶ Make sure the projection screen is between the required distance 4.6 to 39.4 feet (1.4 to 12.0 meters) from the projector.

Problem: Image is reversed.

- ▶ Press “Menu”, then select “Display” to adjust the projection mode.

Problem: Lamp burns out or makes a popping sound

- ▶ When the lamp reaches its end of life, it will burn out and may make a loud popping sound. If this happens, the projector will not turn back on until the lamp module has been replaced. To replace the lamp, follow the procedures in “Replacing the Lamp” page 30.

Problem: LED lighting message

| Message | Power LED | | Temp LED | Lamp LED |
|-------------------------------------|-----------|--------|----------|----------|
| | Green | Orange | | |
| Standby State (Input power cord) | Flashing | Off | Off | Off |
| Lamp lighting | On | Off | Off | Off |
| Power on | On | Off | Off | Off |
| Power off | Off | On | Off | Off |
| Error (Lamp fail) | Off | Off | Off | On |
| Error (Thermal fail) | Off | On | On | Off |
| Error (Fan lock fail) | Off | On | Flashing | Off |
| Error (Over Temp.) | Off | On | Flashing | Off |
| Error (Lamp Breakdown) | Off | On | Off | On |

Problem: Message Reminders

- ▶ “Lamp may fail soon! Replacement suggested!” will be shown about 10 seconds when lamp life is going to deplete.
- ▶ “Over temperature” will be shown when the system temperature is over heat.
- ▶ “Fan fail ” will be shown when the fan is out of order.

Replacing the Lamp

When the projector's lamp usage reaches 1500 hours, it displays the following warning message "Lamp may fail soon ! Replacement Suggested !" When you see this message, please contact your local reseller or service center.

Make sure the projector has cooled down for at least 30 minutes before replacing the lamp.



Warning: Lamp compartment is hot! Allow it to cool down before replacing lamp!

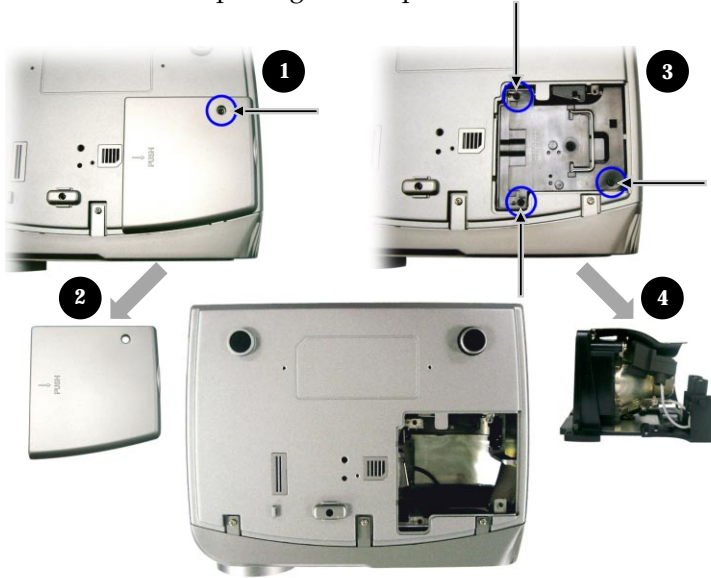

Warning: To reduce the risk of personal injury, avoid dropping the lamp module or touching the lamp bulb. If dropped, the bulb may shatter and cause injury.

Lamp Replacing Procedure:

1. Switch off the power to the projector by pressing the Power button.
2. Allow the projector to cool down at least 30 minutes.
3. Disconnect the power cord.
4. Use a screwdriver to remove the screw from the cover. ❶
5. Push up and remove the cover. ❷
6. Remove the 3 screws from the lamp module. ❸
7. Pull out the lamp module. ❹

To replace the lamp module, reverse the previous steps.

Ceiling Mount Installation

1. To prevent damaging your projector, please use the ceiling mount package for installation.
2. If you wish to use a third party ceiling mount kit please ensure the screws used to attached a mount to the projector met the following specifications:

- ▶ **Screw type: M3**
- ▶ **Maximum screw length: 6mm**



❖ Please note that damage resulting from incorrect installation will invalidate the warranty.

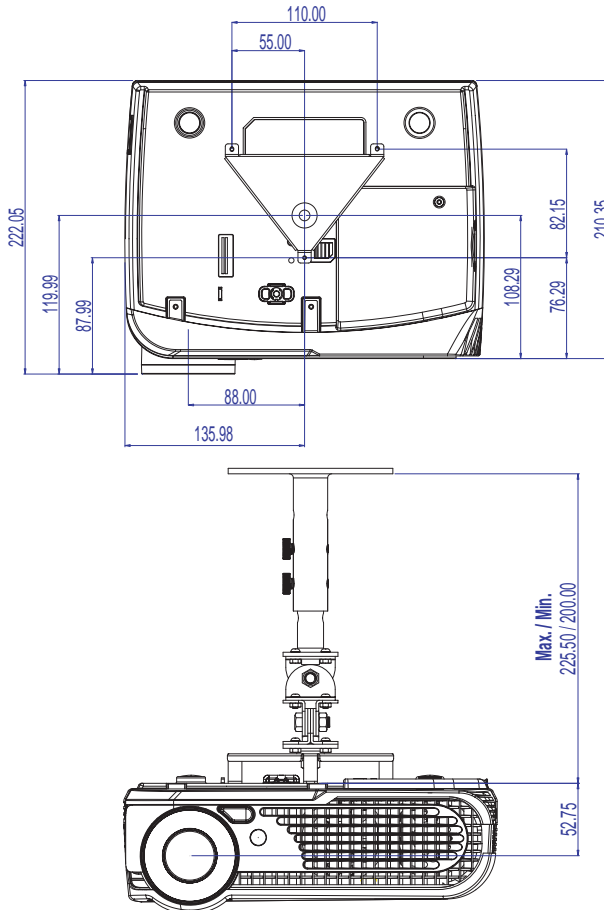

Throw Angle

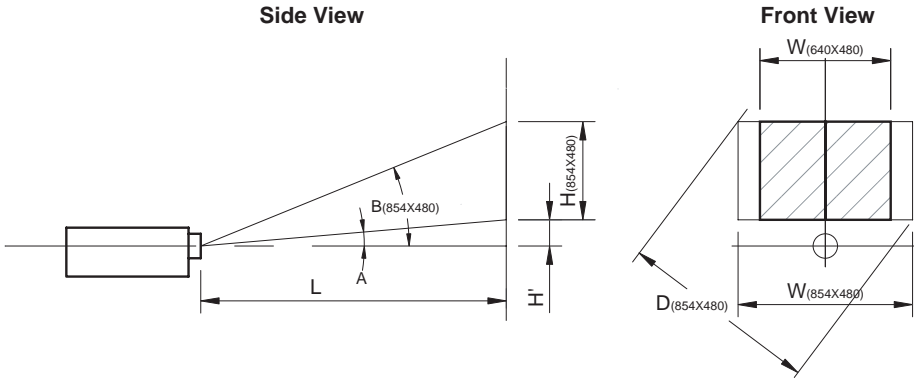

Throw Ratio (TR) = 1.64 as Wide mode

$$A = 7.42^\circ$$

$$B (854 \times 480) = 25.31^\circ$$

$$W (854 \times 480) = L / TR$$

$$W (640 \times 480) = W (854 \times 480) \times 0.75$$

$$H' = L \times \tan (A)$$

$$H (854 \times 480) = W (854 \times 480) \times 0.5625,$$

$$H (640 \times 480) = W (640 \times 480) \times 0.75$$

| Display Format | | A | B | L (cm) | W (cm) | H (cm) | H' (cm) | D (cm) | D (in) |
|----------------|-----------|------|-------|--------|--------|--------|---------|--------|--------|
| 16:9 | 854 x 480 | 7.42 | 25.31 | 218.00 | 132.93 | 74.77 | 28.04 | 152.52 | 60.05 |
| 4:3 | 640 x 480 | 7.42 | 25.31 | 218.00 | 99.62 | 74.77 | 28.04 | 124.56 | 49.04 |